



SIGNATURE

— COLLECTION —

ASSEMBLY INSTRUCTION

NERO 2700 DINING TABLE

ITEM CODE 64243

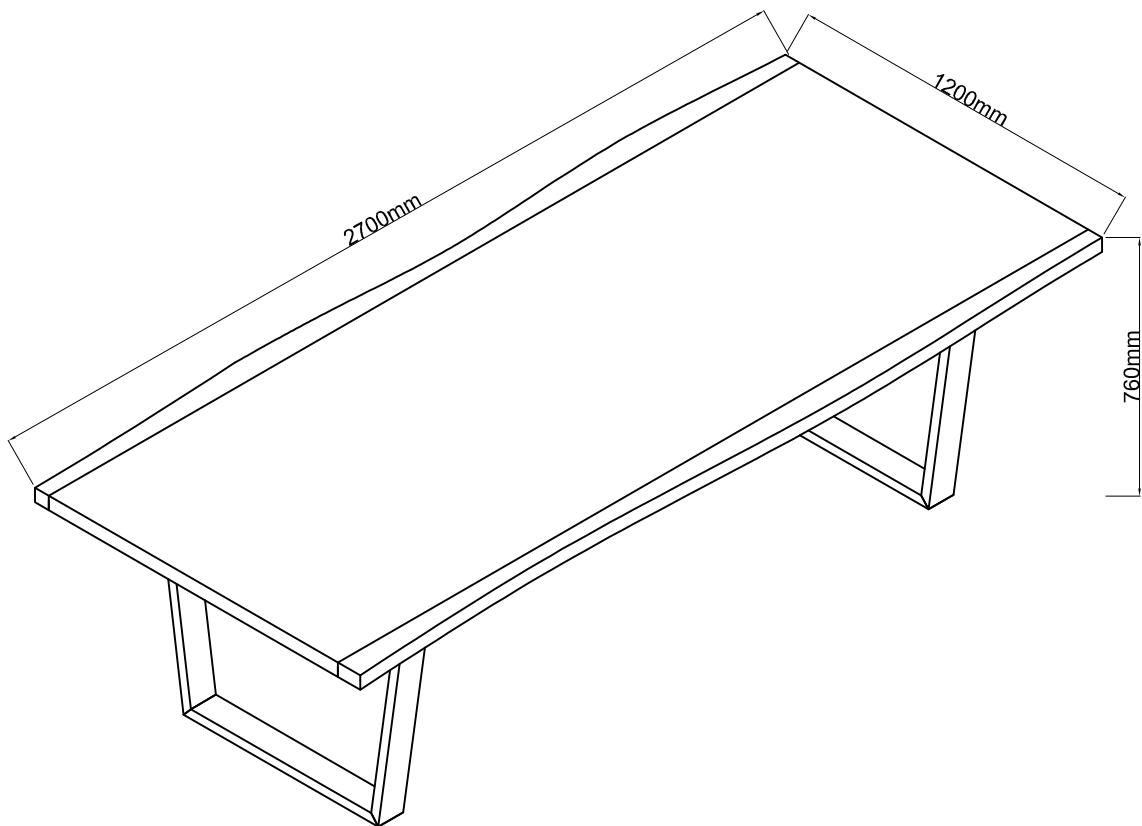

Imported by Amart Furniture Pty Ltd, Qld, Brisbane Australia.
For any assistance with assembly or for missing parts please phone
Amart Furniture, Customer Service Free call 1800 351 084

IMPORTANT: CARE GUIDE FOR YOUR TIMBER FURNITURE

Congratulations! You have just purchased a quality product from Amart furniture.

Please read on for important information regarding your purchase...

A multi-step finish is applied to all our furniture, but all wood comes from nature. Because of this, there will be natural variations in surface texture and grain like knots, mineral streaks and sap runs that may affect the finish.

These differences in character are not defects, but distinctions that make each piece of furniture unique.

Our furniture is built to last. Following these steps, basic care should protect your investment for years to come.

- Dust frequently with a clean damp lint-free cloth. This will help remove abrasive build up which can damage a finish over time.
- Do not place hot objects on any furniture surface. Always use a suitable placemat. Laminate and lacquer finishes on table tops provide added scratch and heat resistance to our furniture, but they can still be damaged without proper care.
- Avoid exposing your furniture to strong sunlight, heat, open windows or dampness. Prolonged exposure to direct sunlight can fade the finish of your furniture, and sudden extreme temperature and humidity changes can cause cracking or splitting.
- Do not expose your furniture to any liquids. Never allow water to sit on your furniture. Alcohol, nail polish and perfume are also dangerous as they will dissolve the lacquer finish on contact and may require professional repairs.
- Do not allow plastic to come in direct contact with your furniture. Chemicals in the plastic of placemats etc may soften and mark the finish if left in contact with the furniture for a period of time.



PRE-ASSEMBLY PREPARATION

Before you start:



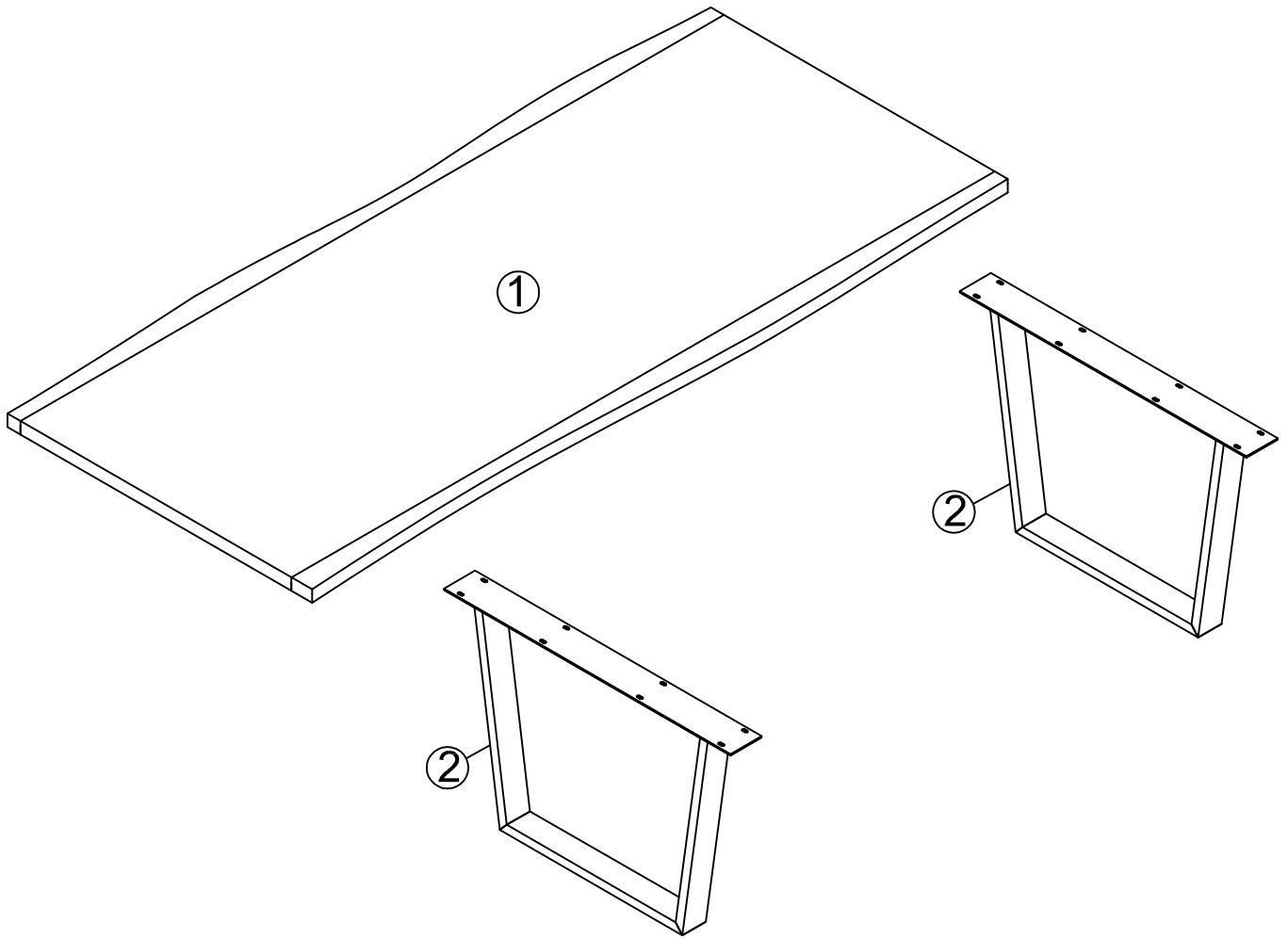

1. Choose a clean, level, spacious assembly area. Avoid hard surfaces that may damage the product
2. Take care when lifting. Product should be assembled as near as possible to the point of use
3. Ensure that you have all required contents for complete assembly
4. Always read the assembly instructions carefully before beginning assembly.
5. Keep all hardware parts and packaging out of reach of small children.
6. Do not over tighten the screws and bolts as this may damage the threads

	
ALLOW 20 MINUTES	2 PEOPLE REQUIRED
ADDITIONAL TOOLS REQUIRED	

PARTS LIST



NO.	PARTS LIST	QT'Y
1	Table top	1 pc
2	Table leg	2 pcs

NO.	HARDWARE LIST		QT'Y
A		Bolt M8x20mm	16 pcs
B		Flat washer M8	16 pcs
C		Spring washer M8	16 pcs
D		Allen Key 4mm	1 pc
E		Adhesive felt pad 20x20x5mm	8 pcs

STEP 1: Attach legs (2) onto top (1) using the bolts M8x20 (A), flat washers (B) and spring washers (C), tighten it up by using an allen key (D). Attach adhesive felt pad (E) onto the legs (2)

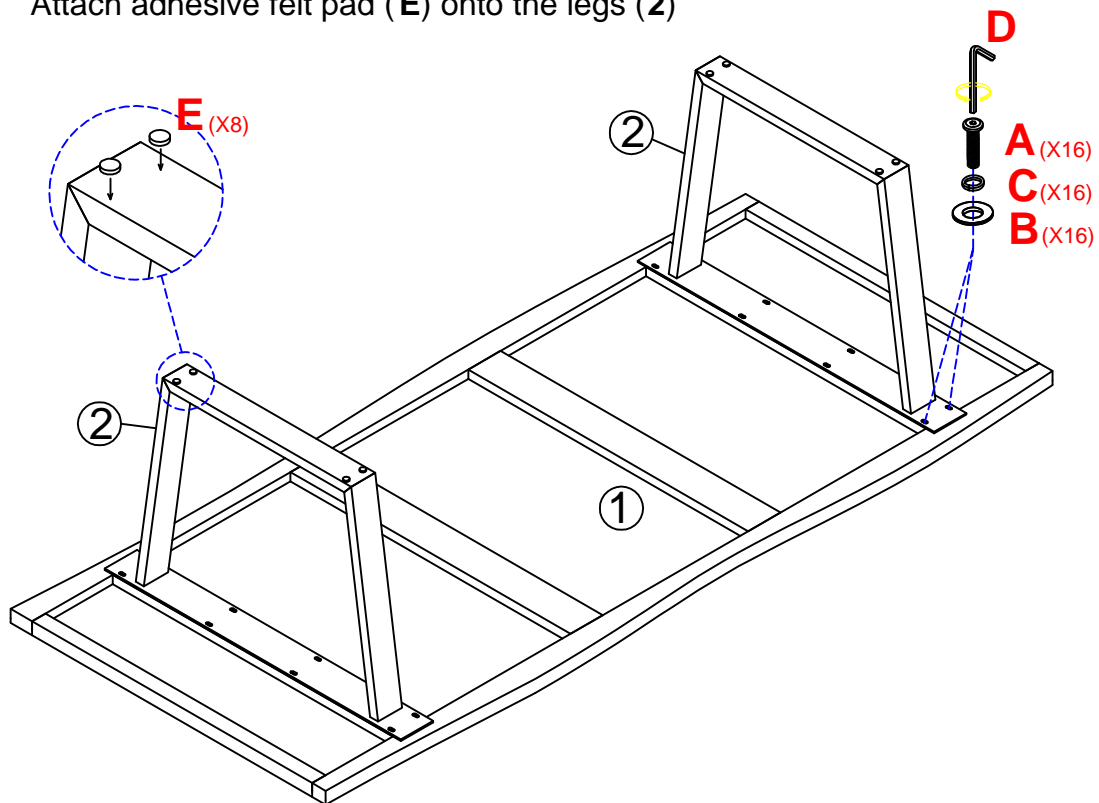

Cautions: Always use two people to turn table upright.

ASSEMBLY IS COMPLETE

